

Telefon 069 / 665 759 62



Yealink Network Technology CO., LTD

Yealink VC400 Video Conferencing System Quick Start Guide

V20.1

Applies to firmware version 30.20.0.1 or later





Table of Contents

Packaging Contents	1
Connections	2
Remote Control and Cable Ties Installation	3
Bracket and Camera Installation	4

Main Screen	6
Network Deployment	7
Troubleshooting	10



Packaging Contents

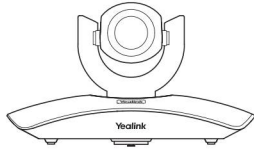

VCC18 Camera

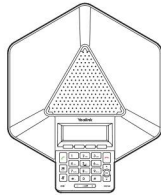

VCP40 Video Conferencing Phone



VC400 Codec



VCR10 Remote Control



AAA Batteries × 2



DVI Cable



VGA Cable



HDMI Cable × 2



3.5mm Audio Cable



Ethernet Cable
(2m)



Ethernet Cable
(7.5m)

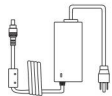

Power Adapter

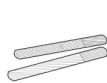

Cable Ties × 7



Quick Start Guide

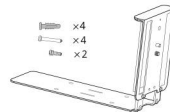

Camera Wall Mount Accessories



Velcro × 2



Optional Accessory



Please use the Yealink-customized DVI cable



We recommend that you use the accessories provided or approved by Yealink. The use of unapproved third-party accessories may result in reduced performance.

Connections

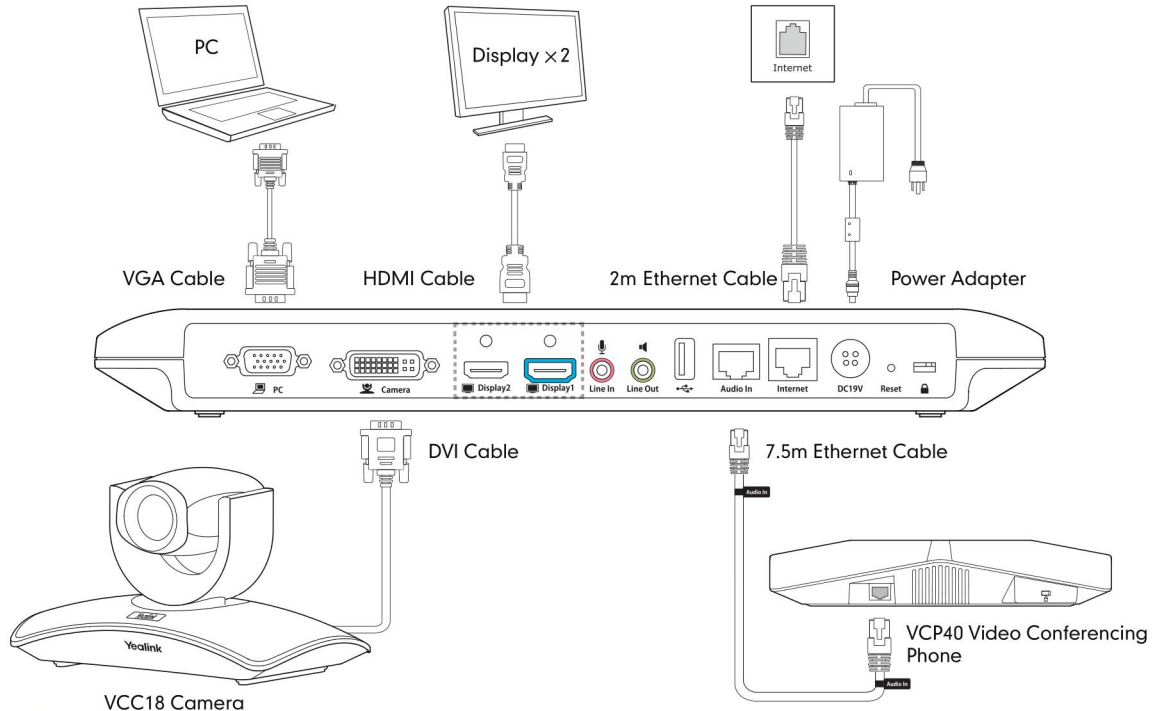

💡 Please connect to the Display1 port if you only have one display device

💡 The system should be used with Yealink original power adapter (19V/3.42A) only. The use of the third-party power adapter may cause the damage to the system

Remote Control and Cable Ties Installation

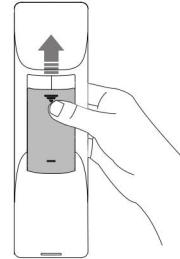
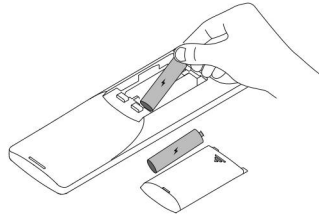

Install batteries

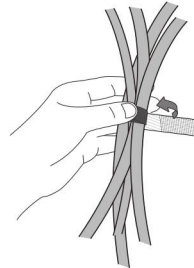
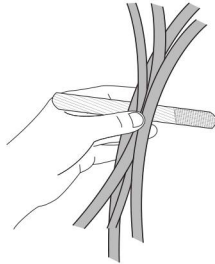

Fasten the cables with the cable tie

Bracket and Camera Installation

- Hanging Mode

Please chose the following installation mode when the thickness of the TV is between 35-120mm

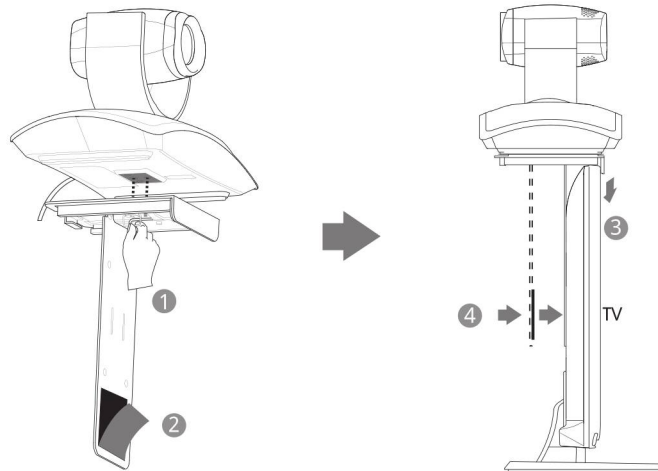

Steps: ① Lock the Camera ② Remove the protection of the Velcro ③ Install bracket ④ Make sure the back of the TV is clean, and then adjust the bracket to ensure close adhesion to the back of the TV with Velcro

4



Adjust the bracket to ensure close adhesion to the back of the TV

● Wall Mount Method

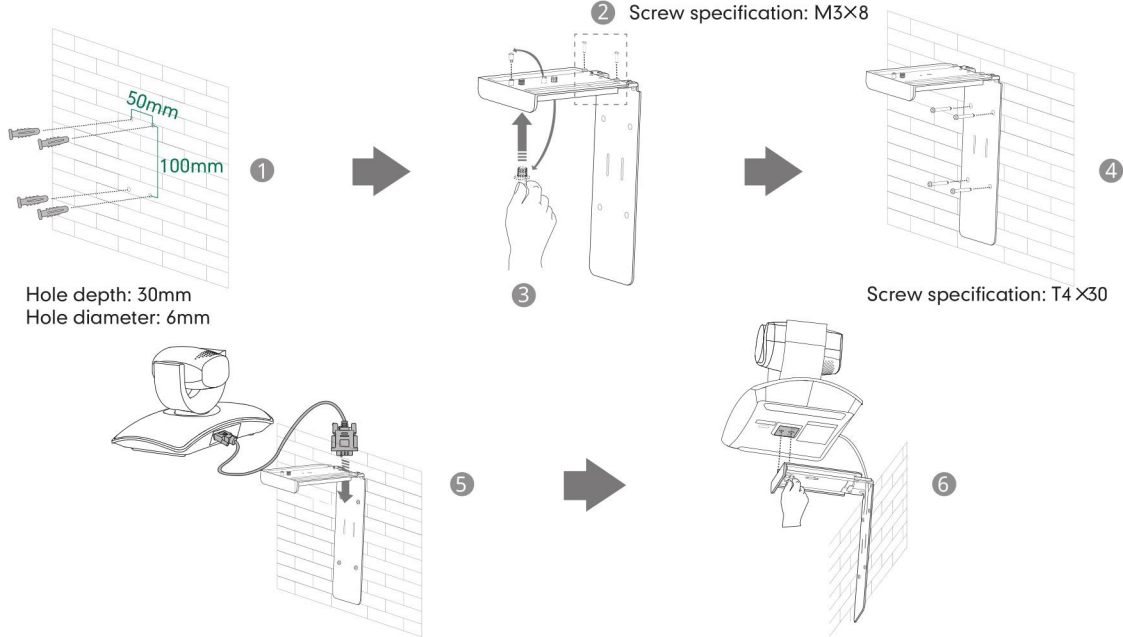

- Steps: ① Punch holes & Insert expansion bolts ② Drive screws ③ Adjust the screws position and manually lock them
④ Insert screws to lock the bracket to the wall ⑤ Connect DVI cable ⑥ Lock the camera

💡 The recommended height for camera positioning is 1.5m-1.8m above the ground

Main Screen



Network Deployment

- To ensure that the VC400 works correctly, please configure it according to the conference role that it plays. If it is in the head office, please make sure that it can be reached from the public network. If it is in a branch office, please use an intelligent firewall to deploy it, or just follow the same steps as for the head office

Head Office

- At least one static public IP address is required in the head office to allow branch offices to connect. The recommended system configurations are as follows :
 - To deploy the VC400 on a public network, you need to assign a static public IP address to the VC400.
 - To deploy the VC400 in an Intranet, you must assign a static private IP address behind the firewall to the VC400. In the meantime, do port mapping on the firewall for VC400.

Configure a Static IP

- Firstly, configure a static IP for the VC400.
- For example: you can use the remote control to configure the IP 10.3.20.12 to your VC400.
 - Menu->Advanced (Admin Password:0000)->LAN Configuration
 - Turn off the **【DHCP】**
 - Enter the IP address, subnet mask, gateway and DNS information in corresponding fields.

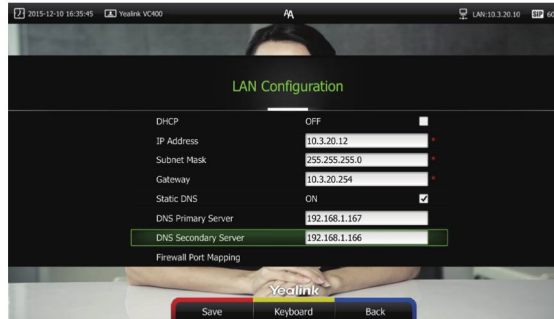

- Press **【Save】** to save the configuration, then the screen prompts **【Reboot now】** . Press **【OK】** to reboot the system.

Configure Port Mapping

If the VC400 is deployed in an Intranet, you need to finish the following port mapping on the firewall:

Function	Port	Protocol Type
H.323 signal port	1719-1720	UDP/TCP
Audio & Video media stream port	50000-50499	TCP/UDP
Web management port (optional)	443	TCP
SIP (optional)	5060	TCP/UDP

Branch Office

- If you are in a branch office, following two options are suggested:

Option1: Deploy the VC400 following the same steps as for the head office. In this way, both inbound and outbound calls will be available.

Option2: Deploy the VC400 using an intelligent firewall, which means that plug and play is possible without any further firewall configuration, but only outbound calls are available.

 Please note that when the VC400 is deployed with an intelligent firewall, you have to open ports (as shown below) permission if they are restricted

 It is recommended that you forward the web management port(443/TCP) to the public network, so that the head office can remotely manage the branch office.

Function	Port	Protocol Type
H.323 signal port	1719-1720	TCP/UDP
Audio & Video media stream port	50000-50499	TCP/UDP
SIP (optional)	5060	TCP/UDP

Bandwidth Requirements

- To ensure the best video conference performance , the recommended bandwidth for VC400 is as below:

Video Resolution	Recommended Bandwidth
Full HD 1080P	1.3Mb
People 1080P+Content 1080P	2.6Mb

- 💡 For more information on configurations, contact your system administrator.
- 💡 The bandwidth mentioned above is based on a two-way conference. Head office bandwidth should be increased in line with the growing number of connected branch offices.

Troubleshooting

- After installation and deployment, you can test the VC400 by dialing the Yealink Demo Room. If you can't dial out successfully, please contact your IT administrator to check the internal network configuration.
- Assume that you are A in head office. Using the configuration method explained in "Head Office" chapter on page 7, you find that you can call B in branch office or Yealink Demo, but that they cannot call you. The most likely reason is that the firewall or gateway in the environment does not support the H.323 ALG feature. In this situation, please take the following actions so that the

NAT feature on the VC400 can solve this problem. (Carry out each step via the remote control)

- Menu->Advanced(Admin Password:0000)->NAT/Firewall
- Select **【Auto】** from the **【Type】** pull-down list, the system will obtain public IP address automatically.
- If the system does not obtain a public IP address automatically, select **【Manual Settings】** from the **【Type】** pull-down list, and then enter the public IP address in the **【Public IP Address】** field.

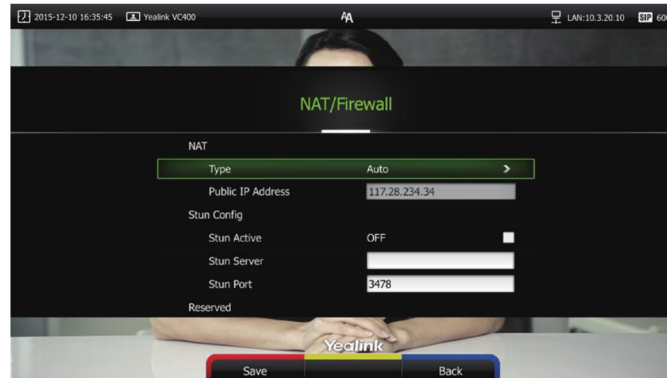

Yealink Test Room IP: 117.28.251.50、 117.28.251.51



For more information, visit the Yealink website:
www.yealink.com



YEALINK NETWORK TECHNOLOGY CO.,LTD.
Web: www.yealink.com
Addr: 4th-5th Floor, South Building, No.63
Wanghai Road, 2nd Software Park,
Xiamen, China(361008)
Copyright©2015Yealink Inc.All right reserved.